

---

## INSTALLATION INSTRUCTIONS

Willoughby AquaDecks™:

**WAD-2230 Series**

**WAD-2235 Series**

**WAD-2240 Series**

**WAD-2250 Series**



Visit our website at <http://www.willoughby-ind.com>  
2210 West Morris Street • P.O. Box 21217 • Indianapolis, IN 46221  
(317) 638-2381 • Fax: (317) 638-6110 • (800) 428-4065

Rev. 1/2007

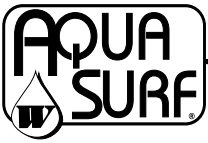

**Willoughby AquaDeck™  
General Dimensions and Rough-Ins**

**Model Number**

**Corner Configuration**

**Cross-section**

**WAD-2230-\***

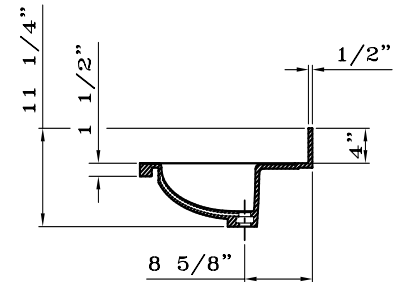
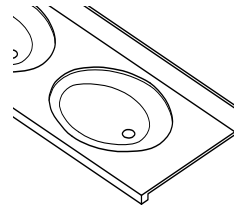

**WAD-2235-\***

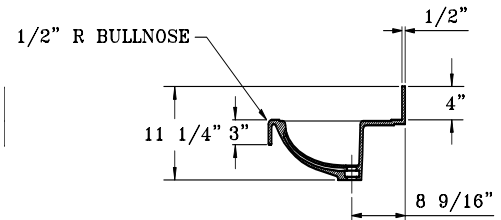
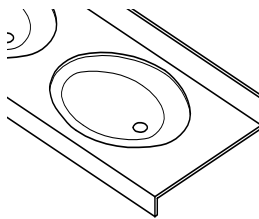

**WAD-2240-\***

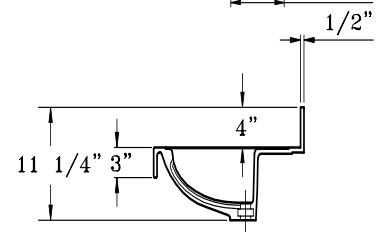
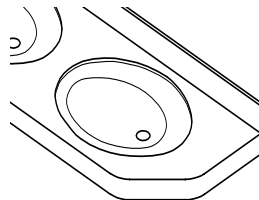

**WAD-2250-\***

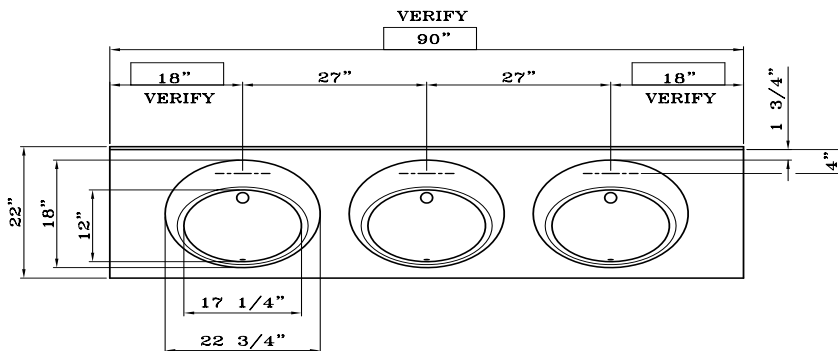
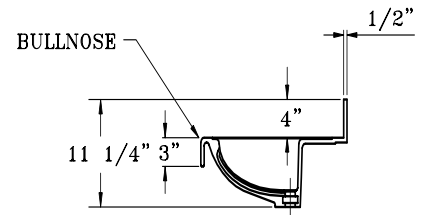
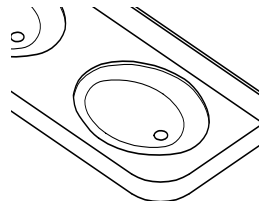

These dimensions are typical for all four series of AquaDecks™. There is 27" from bowl centerline to centerline. The overall length for any standard AquaDeck™ is equal the number of bowls X 30".

\* The model number suffix is the number of bowls, e.g. WAD-2230-2 for a two-station

Visit our website at <http://www.willoughby-ind.com>

2210 West Morris Street • P.O. Box 21217 • Indianapolis, IN 46221

(317) 638-2381 • Fax: (317) 638-6110 • (800) 428-4065

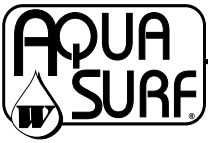

## STEP ONE Wall Mounting

### Parts supplied:

- AquaDeck™ lavatory deck
- Mounting brackets
- Mounting bracket screws and washers

*Note: Wall mounting fasteners by others.*

- 1.) Measure and mark a level line on the wall at 5/8" below the desired counter top height (this line is a guide for the top of the brackets).
- 2.) Measure and mark the bracket locations as shown below. Drill holes in the wall using mounting bracket as a template.
- 3.) Install wall anchors that are suitable for wall material (*supplied by others*). Some wall materials will require additional reinforcement.
- 4.) Secure the mounting brackets to wall. Use left and right brackets as needed.  
*Note: Be sure mounting bracket is level and plumb against wall so that lavatory will drain correctly once assembly is completed.*
- 5.) Measure and cut hole(s) in AquaDeck™ top per faucet manufacturer's specifications.
- 6.) With the help of another person, place the AquaDeck™ on the wall brackets and align the brass inserts with holes in the bracket.
- 7.) Secure AquaDeck™ with the hardware provided.
- 8.) Mount faucet and drain assembly per faucet manufacturer's specifications.

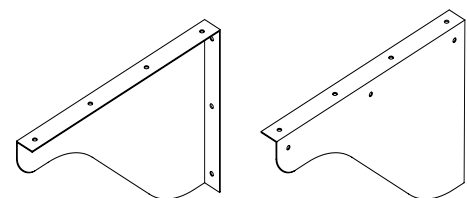
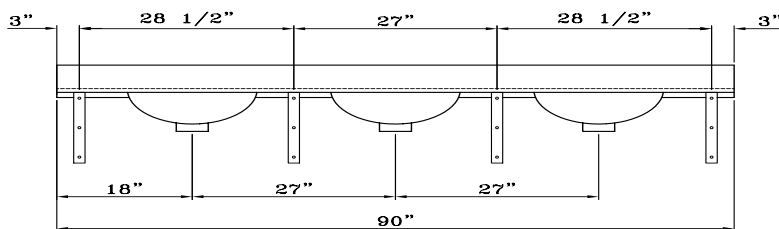
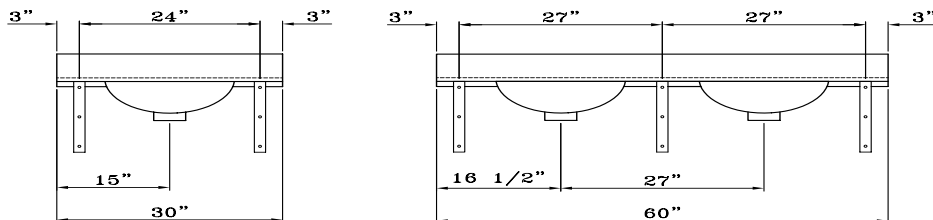

AquaDeck Mounting Brackets

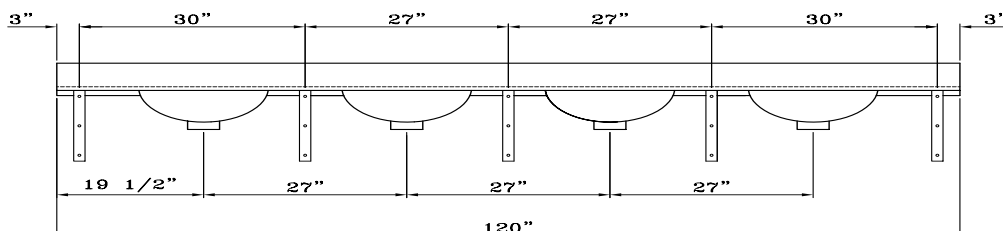

Visit our website at <http://www.willoughby-ind.com>

2210 West Morris Street • P.O. Box 21217 • Indianapolis, IN 46221

(317) 638-2381 • Fax: (317) 638-6110 • (800) 428-4065

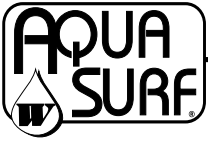

## Aquasurf® Solid Surface Warranty

Aquasurf® Solid Surface Products are a homogeneous blend of resins, mineral filler and colorant manufactured for panels, molded and/or shaped products and components. Aquasurf® Solid Surface products provide a luxurious appearance with the durability of stain proof, impact resistant, burn resistant material with ease of maintenance and cleaning.

Willoughby Industries, Inc. warrants to commercial and institutional purchasers only that each unit will be free from defects in workmanship and materials under normal use and service upon the following terms and conditions. The period during which Aquasurf® components are warranted as follows:

1. Aquasurf® solid surface components are warranted for 2 years from date of shipment.
2. All other components warranted for 1 year from date of shipment.

This warranty does not cover installation or any other labor charges and does not apply to any components damaged by accident, abuse, improper installation or improper maintenance. This warranty does not cover any installation that did not comply with national, state and local building, plumbing, or electrical codes. The warranty is limited to replacing or repairing at Willoughbys option, transportation charges prepaid by the purchaser, any Aquasurf® component or part which upon our inspection shall be deemed as defective within the limitations of this warranty. The replacement or repair of defective units as stated in this warranty shall constitute the sole remedy of the purchaser and the sole liability of Willoughby Industries, Inc. Willoughby Industries, Inc. shall not otherwise be liable under any indirect damages caused by defects in the repair or replacement thereof.

This warranty only extends to commercial and institutional purchasers and does not extend to any others, including consumer customers of commercial institutional purchasers. This warranty is in lieu of all other warranties, expressed or implied, including implied warranty of merchantability or fitness for a particular purpose or otherwise.

*Visit our website at <http://www.willoughby-ind.com>*

2210 West Morris Street • P.O. Box 21217 • Indianapolis, IN 46221

(317) 638-2381 • Fax: (317) 638-6110 • (800) 428-4065

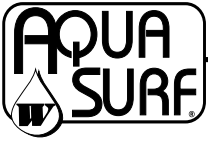

## Care and Maintenance

### Solid Surface Care

Aquasurf® surfaces may be easily cleaned using conventional cleaning agents such as an ammonia based liquid cleaner, (glass cleaner).

Dry stains on a matte finish can be removed with a 3M Scotch-Brite gray scouring pad or a mild abrasive cleaner.

Burns or scorches can be removed by sanding with coarse grit sandpaper followed by finer grit (220) sandpaper. Follow sanding with a 3M Scotch-Brite gray pad (or equivalent) to match finish of sanding area to surrounding area. A final buffing may be required on polished surfaces. Accidental nicks or chips can be repaired with special patch kits available in all Aquasurf® colors.

Avoid exposing Aquasurf® surfaces to strong chemicals such as acetone's; paint removers and sulfuric acid or hydrochloric chemical cleaners. Exposure to strong chemicals may result in permanent damage to Aquasurf® surfaces.

### Stainless Steel Care

Stainless Steels are basically alloys of iron and chromium, and are corrosion resistant. Stainless steel has a bright surface that is easy to clean and is free from oxides. Therefore, cleaning of stainless steel is relatively simple and easy if done on a regular basis.

Frequency of cleaning should depend on the rate at which the fixture becomes dirty. Remember that fresh (soft) deposits of all kinds are relatively easy to remove, while removing older (hard) deposits are much more difficult. Establish a cleaning SCHEDULE.

Routine cleaning should involve ordinary soap or detergent and water, applied with a sponge, brush or cloth. Baking soda, borax or any of several non-abrasive commercial cleansing agents can help hasten the cleaning action. After scrubbing, rinse THOROUGHLY and wipe dry.

DO NOT use common steel wool, scouring pads, scrapers, wire brushes, files or other steel tools to clean stainless steel. Such items will scratch the surface or leave small particles of iron imbedded in the surface, which will eventually rust and stain the surface—even appearing as if the stainless itself was rusting.

Certain chemical compounds, if used on stainless steel, can give the appearance of rust and if allowed to stand for long periods of time, can pit the surface of even stainless. Products containing hydrochloric acid, muriatic acid or potassium hydrochloride can ruin the surface.

*Visit our website at <http://www.willoughby-ind.com>*

2210 West Morris Street • P.O. Box 21217 • Indianapolis, IN 46221

(317) 638-2381 • Fax: (317) 638-6110 • (800) 428-4065